



# Stratoflex

*3175 PTFE Medium Pressure Hose  
Products for the Aerospace Industry*

*Catalog 106-3175  
March 2004*



*The World Standard*

## **DANGER**

FAILURE OR IMPROPER SELECTION OR IMPROPER USE OF THE PRODUCTS AND/OR SYSTEMS DESCRIBED HEREIN OR RELATED ITEMS CAN CAUSE DEATH, PERSONAL INJURY AND PROPERTY DAMAGE.

Before selecting or using any Parker hose or fittings or related accessories, it is important that you read and follow Parker Safety Guide for Selecting and Using Hoses, Fittings, and Related Accessories (Parker Publication No. 4400-B.1)

This document and other information from Parker Hannifin Corporation, its subsidiaries and authorized distributors, provide product and/or system options for further investigation by users having technical expertise. It is important that you analyze all aspects of your application and review the information concerning the product or system in the current product catalog. Due to the variety of operating conditions and applications for these products or systems, the user, through its own analysis and testing, is solely responsible for making the final selection of the products and systems and assuring that all performance, safety and warning requirements of the application are met.

The products described herein, including without limitation, product features, specifications, designs, availability and pricing, are subject to change by Parker Hannifin Corporation and its subsidiaries at any time without notice.

## **Offer of Sale**

The items described in this document are hereby offered for sale by Parker Hannifin Corporation, its subsidiaries or its authorized distributors. This offer and its acceptance are governed by the provisions in the "Offer of Sale".

© 1991-2004 Parker Hannifin Corporation















**Parker Hannifin Corporation**  
Stratoflex Products Division  
Fort Worth, Texas

# Table of Contents

|  |       |
|--|-------|
| How to Use This Catalog.....                   | 2     |
| Ordering Information for Standard Items .....  | 3-4   |
| Stratoflex "Twist Angle" Information .....     | 4     |
| Measurement of Flareless Hose Assemblies ..... | 4     |
| 3175 Hose .....                                | 5     |
| 3175 Hose Fittings (Crimp) .....               | 6-8   |
| 3175 Flare Hose Assemblies (Crimp) .....       | 9-12  |
| 3175 Flareless Hose Assemblies (Crimp) .....   | 13-16 |
| Safety Guide.....                              | 17-18 |
| Offer of Sale .....                            | 19    |

# How to Use This Catalog

- If you know the type of part (fitting, hose assembly, etc.), see the Table of Contents on page 1.
- The Stratoflex part numbering system for Hose, Fittings and Hose Assemblies is defined on page 3.
- The Stratoflex Hose and Fitting information tables have international symbols as column heads. The symbols and their meaning are noted below.

| SYMBOL  | DEFINITION          | SYMBOL   | DEFINITION               |
|---|---------------------|--|--------------------------|
| #   | Part Number         |     | Vacuum Rating            |
|    | Hose Inner Diameter |     | Crimp Fitting            |
|    | Hose Outer Diameter |    | Field Attachable Fitting |
|    | Working Pressure    |     | Page Number              |
|  | Burst Pressure      |  | Thread Size              |
|  | Minimum Bend Radius |   | Hex Size                 |
|  | Weight              |   | Diameter                 |

# Ordering Information for Standard Items

## 1. HOSE ASSEMBLY:

### STRAIGHT TO STRAIGHT (OR STRAIGHT TO SINGLE ELBOW) EXAMPLE:

**3175001-8CR-0185**

Basic Hose Assembly Number

Size (1/2" O.D. Tube Size) In 1/16"

Assembly length in inches to three digits. The last digit specifies eighths of an inch.

See Material Note Below

### DOUBLE ELBOW EXAMPLE: **3175060E0185C180**

Basic Hose Assembly Number

Size (1/2" O.D. Tube Size) In 1/16"

Twist Angle (180° - See Page 4)

See Material Note Below

Assembly length in inches. The last digit specifies eighths of an Inch.

### SIZE CODE FOR DOUBLE ELBOW HOSE ASSEMBLIES

|                |    |    |    |    |    |
|----------------|----|----|----|----|----|
| DASH SIZE      | -3 | -4 | -5 | -6 | -8 |
| SF CODE LETTER | A  | B  | C  | D  | E  |

### MATERIAL: Per AS4897

C or CR - Corrosion resistant stainless steel

D\* - Aluminum with CR socket

CL - Same as CR except lockwire holes in nut

NOTE: Aluminum fitting not per AS4897

LENGTH MEASUREMENT - Length is measured along hose centerline from end of nipple to end of nipple

NOTE: For additional information on special materials or accessories not shown, contact Stratoflex.

NOTE: Unless otherwise noted, dimensions shown herein are nominal and are subject to change without notice. Contact Stratoflex Customer Service for current data.

## 2. IDENTIFICATION BANDS: An example of Identification bands used when required for Hose Assemblies:

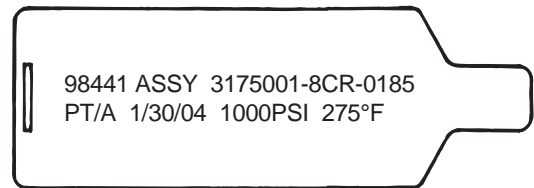

\* Will include aluminum nut and nipple with CR (CRES) socket.

# Ordering Information for Standard Items

## STRATOFLEX "TWIST ANGLE" INFORMATION

### HOW TO MEASURE AND SPECIFY POSITIONING OF FITTINGS WHEN TWO ELBOW FITTINGS ARE REQUIRED ON A HOSE ASSEMBLY



**MEASURING:** When installations require hose assemblies with elbow fittings on both ends, hold the assembly so that the nearest fitting is pointing in the 6 o'clock position. Measure angle between fittings, counterclockwise. Both fittings pointing to 6 o'clock will be specified as zero degrees (0°).

**SPECIFYING POSITION:** Add a suffix to the hose assembly part number with the number of degrees in the angle. (Example: 3175060E0185C180; 180° Twist Angle.) The standard tolerance is +/-2°.

**NOTE:** Elbow Hose Fittings shown in this catalog are STRATOFLEX standard type designs. If your installation requires a fitting of a different angle or connection, submit a print for Stratoflex Engineering evaluation.

**USE CAUTION AS TO NOT INFLICT A TWIST IN THE HOSE.**

## MEASUREMENT OF FLARELESS HOSE ASSEMBLIES

NAS 1760 Nipple end design is supplied by Stratoflex on flareless hose fittings. Flareless hose assembly length "L" is measured from END of nipple to END of nipple. To convert "END to END" to "GAGE POINT to GAGE POINT" measurement, subtract from "L" the appropriate "B or C" dimension shown in table below for each end fitting. The figures and table below give a comparison of NAS 1760 nipple end design and Stratoflex Radius Seal end design.

**NOTE: ALL HOSE FITTINGS ARE MEASURED AT THE CENTERLINE FOR LENGTH AND DROP DIMENSIONS.**

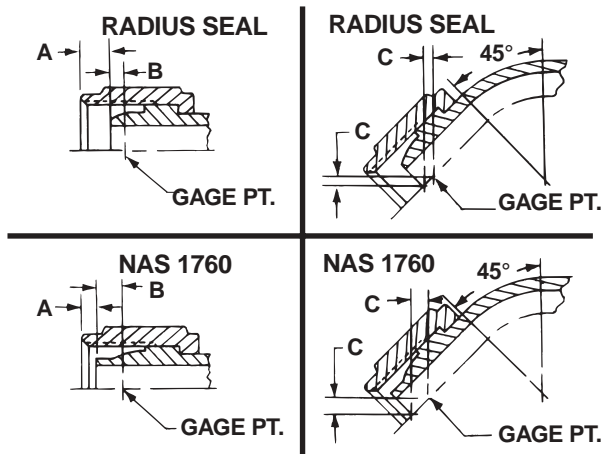

| Dash Size | A           |             |             | B           |             |             | C           |             |             |
|-----------|-------------|-------------|-------------|-------------|-------------|-------------|-------------|-------------|-------------|
|           | NAS         | Radius      | Diff.       | NAS         | Radius      | Diff.       | NAS         | Radius      | Diff.       |
| 3         | <b>.123</b> | <b>.138</b> | <b>.015</b> | <b>.140</b> | <b>.085</b> | <b>.055</b> | <b>.099</b> | <b>.060</b> | <b>.039</b> |
|           | <i>3.12</i> | <i>3.50</i> | <i>.38</i>  | <i>3.56</i> | <i>2.16</i> | <i>1.40</i> | <i>2.51</i> | <i>1.52</i> | <i>.99</i>  |
| 4         | <b>.176</b> | <b>.207</b> | <b>.031</b> | <b>.155</b> | <b>.062</b> | <b>.093</b> | <b>.110</b> | <b>.044</b> | <b>.066</b> |
|           | <i>4.47</i> | <i>5.26</i> | <i>.79</i>  | <i>3.94</i> | <i>1.57</i> | <i>2.36</i> | <i>2.79</i> | <i>1.12</i> | <i>1.68</i> |
| 5         | <b>.160</b> | <b>.227</b> | <b>.067</b> | <b>.157</b> | <b>.058</b> | <b>.099</b> | <b>.111</b> | <b>.041</b> | <b>.070</b> |
|           | <i>4.06</i> | <i>5.77</i> | <i>1.70</i> | <i>3.99</i> | <i>1.47</i> | <i>2.51</i> | <i>2.82</i> | <i>1.04</i> | <i>1.78</i> |
| 6         | <b>.173</b> | <b>.198</b> | <b>.025</b> | <b>.164</b> | <b>.059</b> | <b>.105</b> | <b>.116</b> | <b>.042</b> | <b>.074</b> |
|           | <i>4.39</i> | <i>5.03</i> | <i>.64</i>  | <i>4.17</i> | <i>1.50</i> | <i>2.67</i> | <i>2.95</i> | <i>1.07</i> | <i>1.88</i> |
| 8         | <b>.191</b> | <b>.217</b> | <b>.026</b> | <b>.189</b> | <b>.064</b> | <b>.125</b> | <b>.134</b> | <b>.045</b> | <b>.089</b> |
|           | <i>4.85</i> | <i>5.51</i> | <i>.66</i>  | <i>4.80</i> | <i>1.63</i> | <i>3.18</i> | <i>3.40</i> | <i>1.14</i> | <i>2.26</i> |

**NOTE:** English measurements in **BOLD**;  
metric measurements in *ITALICS* (mm).

# 3175 PTFE Hose

## 3175 PTFE Hose



### SPECIFICATIONS:

Hose qualified in accordance with applicable requirements of HS3175 and tested per AS2078.

### CONSTRUCTION:

**Tube** - Seamless extruded, conductive, smooth bore PTFE.

**Reinforcement** - Corrosion-resistant steel wire braid.

**Cover** - Black Cordura® abrasion resistant braid.

### IDENTIFICATION:

Stratoflex identification and part number.





**APPLICATION:** Medium pressure, low temperature aerospace fluid transfer systems requiring a small bend radius and lightweight design. For use in non-fire zones.

### TEMPERATURE RANGE:

-65 to +275°F (-54 to + 135°C)

Teflon® and Codura® are registered trademarks of E.I. du Pont Nemours and Company. Teflon® is used under license by Parker Hannifin Corporation, Stratoflex Products Division.

**NOTE:** English measurements in **BOLD**; metric measurements in *ITALICS* (pressures in bars; dimensions in mm).

| #      | Hose Size | Minimum                     | Maximum                      |  |  |                              |  | <br>@ 120 psi<br>@ 8.27 bar |  lb/in<br>Nominal |
|--------|-----------|-----------------------------|------------------------------|---|---|------------------------------|---|--|--|
|        |           |                             |                              |   | Min. @ 70°F<br>Min. @ 21°C  | Min. @ 275°F<br>Min. @ 135°C |   |  |  |
| 3175-3 | -3        | <b>.110</b><br><i>2.794</i> | <b>.335</b><br><i>8.509</i>  | <b>2000</b><br><i>137.90</i>  | <b>8000</b><br><i>551.58</i>  | <b>6000</b><br><i>413.69</i> | <b>.75</b><br><i>19.05</i>  | <b>0.20</b><br><i>5.08</i>   | <b>.004</b>  |
| 3175-4 | -4        | <b>.173</b><br><i>4.394</i> | <b>.410</b><br><i>10.414</i> | <b>1500</b><br><i>103.42</i>  | <b>6000</b><br><i>413.69</i>  | <b>4500</b><br><i>310.26</i> | <b>1.00</b><br><i>25.40</i>   | <b>0.30</b><br><i>7.62</i>   | <b>.005</b>  |
| 3175-5 | -5        | <b>.235</b><br><i>5.969</i> | <b>.455</b><br><i>11.557</i> | <b>1000</b><br><i>68.95</i>   | <b>4000</b><br><i>275.79</i>  | <b>3000</b><br><i>206.84</i> | <b>1.25</b><br><i>31.75</i>   | <b>0.50</b><br><i>12.70</i>  | <b>.006</b>  |
| 3175-6 | -6        | <b>.298</b><br><i>7.569</i> | <b>.550</b><br><i>13.970</i> | <b>1000</b><br><i>68.95</i>   | <b>4000</b><br><i>275.79</i>  | <b>3000</b><br><i>206.84</i> | <b>2.00</b><br><i>50.80</i>   | <b>1.00</b><br><i>25.40</i>  | <b>.008</b>  |
| 3175-8 | -8        | <b>.391</b><br><i>9.931</i> | <b>.625</b><br><i>15.875</i> | <b>1000</b><br><i>68.95</i>   | <b>4000</b><br><i>275.79</i>  | <b>3000</b><br><i>206.84</i> | <b>2.00</b><br><i>50.80</i>   | <b>1.50</b><br><i>38.10</i>  | <b>.010</b>  |

### BENEFITS

- Unlimited shelf life
- Compatible with most fluids (see compatibility table)
- Lightweight Design

# 3175 PTFE Hose Fittings

## 418624 Straight Flared Fitting

37° Flare Swivel  
Mates with AS4395/MS33656 type connectors.

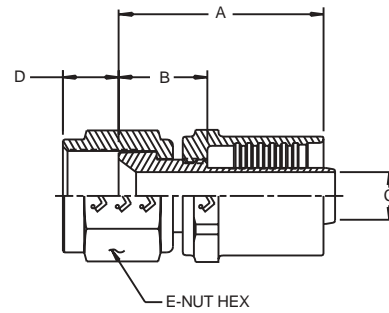

JSA

**NOTE:** English measurements in **BOLD**; metric measurements in *ITALICS* (mm and grams).

| #            | Hose Size |  | After Crimp Max. A          | Cut Factor B               | Min. Ball C                | D                          | E                          | CR Nominal                  | D Nominal                   |
|--------------|-----------|---|-----------------------------|----------------------------|----------------------------|----------------------------|----------------------------|-----------------------------|-----------------------------|
| 418624-3-3CR | -3        | .375-24UNJF-3B  | <b>.97</b><br><i>24.64</i>  | <b>.48</b><br><i>12.19</i> | <b>.072</b><br><i>1.82</i> | <b>.33</b><br><i>8.38</i>  | <b>.50</b><br><i>12.70</i> | <b>.034</b><br><i>15.42</i> | -                           |
| 418624-4-4CR | -4        | .4375-20UNJF-3B   | <b>1.01</b><br><i>25.65</i> | <b>.50</b><br><i>12.70</i> | <b>.119</b><br><i>3.02</i> | <b>.35</b><br><i>8.89</i>  | <b>.56</b><br><i>14.22</i> | <b>.062</b><br><i>28.12</i> | -                           |
| 418624-5-5CR | -5        | .500-20UNJF-3B  | <b>1.13</b><br><i>28.70</i> | <b>.54</b><br><i>13.72</i> | <b>.174</b><br><i>4.41</i> | <b>.38</b><br><i>9.65</i>  | <b>.62</b><br><i>15.75</i> | <b>.069</b><br><i>31.30</i> | -                           |
| 418624-6-6CR | -6        | .5625-18UNJF-3B   | <b>1.24</b><br><i>31.50</i> | <b>.59</b><br><i>14.99</i> | <b>.230</b><br><i>5.84</i> | <b>.38</b><br><i>9.65</i>  | <b>.69</b><br><i>17.53</i> | <b>.094</b><br><i>42.64</i> | -                           |
| 418624-8-8*  | -8        | .750-16UNJF-3B  | <b>1.51</b><br><i>38.35</i> | <b>.72</b><br><i>18.29</i> | <b>.306</b><br><i>7.77</i> | <b>.44</b><br><i>11.18</i> | <b>.88</b><br><i>22.35</i> | <b>.151</b><br><i>68.49</i> | <b>.086</b><br><i>39.01</i> |

## 418626 45° Elbow Flared Fitting

37° Flare Swivel  
Mates with AS4395/MS33656 type connectors.

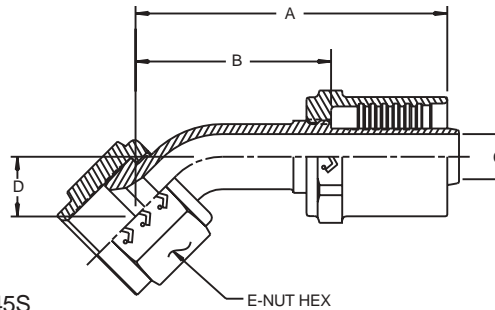

J45S

**NOTE:** English measurements in **BOLD**; metric measurements in *ITALICS* (mm and grams).

| #            | Hose Size |  | After Crimp Max. A          | Cut Factor B                | Min. Ball C                | D                          | E                          | CR Nominal                  | D Nominal                   |
|--------------|-----------|---|-----------------------------|-----------------------------|----------------------------|----------------------------|----------------------------|-----------------------------|-----------------------------|
| 418626-3-3CR | -3        | .375-24UNJF-3B  | <b>1.49</b><br><i>37.85</i> | <b>.87</b><br><i>22.10</i>  | <b>.068</b><br><i>1.72</i> | <b>.33</b><br><i>8.38</i>  | <b>.50</b><br><i>12.70</i> | <b>.039</b><br><i>17.69</i> | -                           |
| 418626-4-4CR | -4        | .4375-20UNJF-3B   | <b>1.65</b><br><i>41.91</i> | <b>1.09</b><br><i>27.69</i> | <b>.112</b><br><i>2.84</i> | <b>.35</b><br><i>8.89</i>  | <b>.56</b><br><i>14.22</i> | <b>.071</b><br><i>32.20</i> | -                           |
| 418626-5-5CR | -5        | .500-20UNJF-3B  | <b>1.94</b><br><i>49.28</i> | <b>1.30</b><br><i>33.02</i> | <b>.164</b><br><i>4.16</i> | <b>.41</b><br><i>10.41</i> | <b>.62</b><br><i>15.75</i> | <b>.081</b><br><i>36.74</i> | -                           |
| 418626-6-6CR | -6        | .5625-18UNJF-3B   | <b>2.04</b><br><i>51.82</i> | <b>1.34</b><br><i>34.04</i> | <b>.218</b><br><i>5.53</i> | <b>.44</b><br><i>11.18</i> | <b>.69</b><br><i>17.53</i> | <b>.120</b><br><i>54.43</i> | -                           |
| 418626-8-8*  | -8        | .750-16UNJF-3B  | <b>2.10</b><br><i>53.34</i> | <b>1.24</b><br><i>31.50</i> | <b>.289</b><br><i>7.34</i> | <b>.46</b><br><i>11.68</i> | <b>.88</b><br><i>22.35</i> | <b>.186</b><br><i>84.37</i> | <b>.094</b><br><i>44.91</i> |

\*Add material designation CR for corrosion resistant steel or D for aluminum nipple and nut with a stainless steel socket.



# 3175 PTFE Hose Fittings

## 418628 90° Elbow Flared Fitting

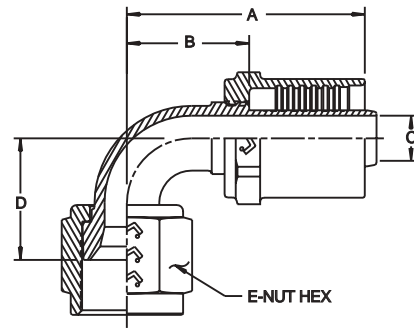

37° Flare Swivel

Mates with AS4395/MS33656 type connectors.

**NOTE:** English measurements in **BOLD**; metric measurements in *ITALICS* (mm and grams).

| #            | Hose Size |  | After Crimp Max. A          | Cut Factor B                | Min. Ball C                | D                          | E                          | CR Nominal                  | D Nominal                   |
|--------------|-----------|---|-----------------------------|-----------------------------|----------------------------|----------------------------|----------------------------|-----------------------------|-----------------------------|
| 418628-3-3CR | -3        | .375-24UNJF-3B  | <b>1.22</b><br><i>30.99</i> | <b>.70</b><br><i>17.78</i>  | <b>.068</b><br><i>1.72</i> | <b>.65</b><br><i>16.51</i> | <b>.50</b><br><i>12.70</i> | <b>.039</b><br><i>17.69</i> | -                           |
| 418628-4-4CR | -4        | .4375-20UNJF-3B   | <b>1.29</b><br><i>32.77</i> | <b>.74</b><br><i>18.80</i>  | <b>.112</b><br><i>2.84</i> | <b>.66</b><br><i>16.76</i> | <b>.56</b><br><i>14.22</i> | <b>.071</b><br><i>32.20</i> | -                           |
| 418628-5-5CR | -5        | .500-20UNJF-3B  | <b>1.45</b><br><i>36.83</i> | <b>.83</b><br><i>21.08</i>  | <b>.164</b><br><i>4.16</i> | <b>.84</b><br><i>21.34</i> | <b>.62</b><br><i>15.75</i> | <b>.081</b><br><i>36.74</i> | -                           |
| 418628-6-6CR | -6        | .5625-18UNJF-3B   | <b>1.57</b><br><i>39.88</i> | <b>.89</b><br><i>22.61</i>  | <b>.218</b><br><i>5.53</i> | <b>.87</b><br><i>22.10</i> | <b>.69</b><br><i>17.53</i> | <b>.120</b><br><i>54.43</i> | -                           |
| 418628-8-8*  | -8        | .750-16UNJF-3B  | <b>1.91</b><br><i>48.51</i> | <b>1.06</b><br><i>26.92</i> | <b>2.89</b><br><i>7.34</i> | <b>.94</b><br><i>23.88</i> | <b>.88</b><br><i>22.35</i> | <b>.186</b><br><i>84.37</i> | <b>.099</b><br><i>44.91</i> |

## 418634 Straight Flareless Fitting

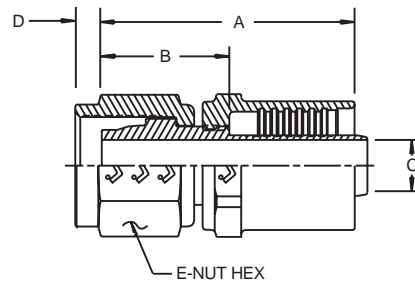

NAS-1760 Flareless Swivel

Mates with AS4375/AS33514 type connectors.

**NOTE:** English measurements in **BOLD**; metric measurements in *ITALICS* (mm and grams).

| #            | Hose Size |  | After Crimp Max. A          | Cut Factor B               | Min. Ball C                | D                         | E                          | CR Nominal                  | D Nominal                   |
|--------------|-----------|---|-----------------------------|----------------------------|----------------------------|---------------------------|----------------------------|-----------------------------|-----------------------------|
| 418634-3-3CR | -3        | .375-24UNJF-3B  | <b>1.19</b><br><i>30.23</i> | <b>.69</b><br><i>17.53</i> | <b>.072</b><br><i>1.82</i> | <b>.12</b><br><i>3.05</i> | <b>.50</b><br><i>12.70</i> | <b>.037</b><br><i>16.78</i> | -                           |
| 418634-4-4CR | -4        | .4375-20UNJF-3B   | <b>1.19</b><br><i>30.23</i> | <b>.69</b><br><i>17.53</i> | <b>.119</b><br><i>3.02</i> | <b>.17</b><br><i>4.32</i> | <b>.56</b><br><i>14.22</i> | <b>.063</b><br><i>28.58</i> | -                           |
| 418634-5-5CR | -5        | .500-20UNJF-3B  | <b>1.36</b><br><i>34.54</i> | <b>.77</b><br><i>19.56</i> | <b>.174</b><br><i>4.41</i> | <b>.16</b><br><i>4.06</i> | <b>.62</b><br><i>15.75</i> | <b>.075</b><br><i>34.02</i> | -                           |
| 418634-6-6CR | -6        | .5625-18UNJF-3B   | <b>1.45</b><br><i>36.83</i> | <b>.80</b><br><i>20.32</i> | <b>.230</b><br><i>5.84</i> | <b>.17</b><br><i>4.32</i> | <b>.69</b><br><i>17.53</i> | <b>.099</b><br><i>44.91</i> | -                           |
| 418634-8-8*  | -8        | .750-16UNJF-3B  | <b>1.72</b><br><i>43.69</i> | <b>.91</b><br><i>23.11</i> | <b>.306</b><br><i>7.77</i> | <b>.19</b><br><i>4.83</i> | <b>.88</b><br><i>22.35</i> | <b>.162</b><br><i>73.48</i> | <b>.090</b><br><i>40.82</i> |

\*Add material designation CR for corrosion resistant steel or D for aluminum nipple and nut with a stainless steel socket.

# 3175 PTFE Hose Fittings

## 418606/418636 45° Elbow Flareless Fitting

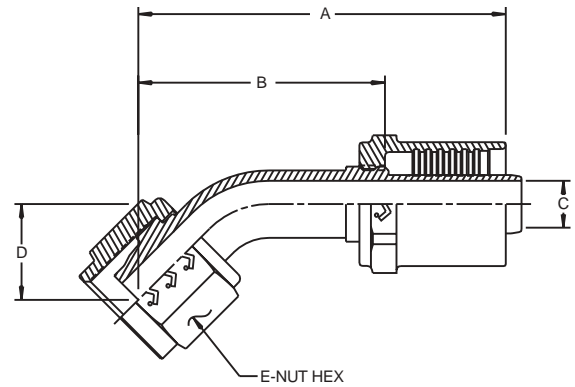

NAS-1760 Flareless Swivel  
Mates with AS4375/AS33514 type connectors.

**NOTE:** English measurements in **BOLD**; metric measurements in *ITALICS* (mm and grams).

| #            | Hose Size |  | After Crimp Max. A          | Cut Factor B                | Min. Ball C                | D                          | E                          | CR Nominal                  | D Nominal                   |
|--------------|-----------|---|-----------------------------|-----------------------------|----------------------------|----------------------------|----------------------------|-----------------------------|-----------------------------|
| 418606-3-3CR | -3        | .375-24UNJF-3B  | <b>1.59</b><br><i>40.39</i> | <b>1.06</b><br><i>26.92</i> | <b>.068</b><br><i>1.72</i> | <b>.52</b><br><i>13.21</i> | <b>.50</b><br><i>12.70</i> | <b>.053</b><br><i>24.04</i> | -                           |
| 418636-4-4CR | -4        | .4375-20UNJF-3B   | <b>1.84</b><br><i>46.74</i> | <b>1.30</b><br><i>33.02</i> | <b>.112</b><br><i>2.84</i> | <b>.53</b><br><i>13.46</i> | <b>.56</b><br><i>14.22</i> | <b>.071</b><br><i>32.20</i> | -                           |
| 418636-5-5CR | -5        | .500-20UNJF-3B  | <b>2.04</b><br><i>51.82</i> | <b>1.41</b><br><i>35.81</i> | <b>.164</b><br><i>4.16</i> | <b>.59</b><br><i>14.99</i> | <b>.62</b><br><i>15.75</i> | <b>.086</b><br><i>39.01</i> | -                           |
| 418636-6-6CR | -6        | .5625-18UNJF-3B   | <b>2.26</b><br><i>57.40</i> | <b>1.57</b><br><i>39.88</i> | <b>.218</b><br><i>5.53</i> | <b>.63</b><br><i>16.00</i> | <b>.69</b><br><i>17.53</i> | <b>.114</b><br><i>51.71</i> | -                           |
| 418636-8-8*  | -8        | .750-16UNJF-3B  | <b>2.71</b><br><i>68.83</i> | <b>1.86</b><br><i>47.24</i> | <b>.289</b><br><i>7.34</i> | <b>.71</b><br><i>18.03</i> | <b>.88</b><br><i>22.35</i> | <b>.197</b><br><i>89.36</i> | <b>.101</b><br><i>45.81</i> |

## 418608/418638 90° Elbow Flareless Fitting

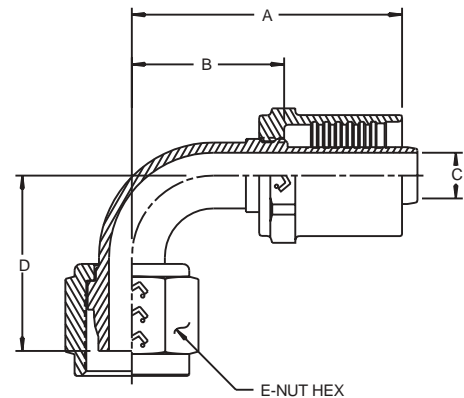

NAS-1760 Flareless Swivel  
Mates with AS4375/AS33514 type connectors.

**NOTE:** English measurements in **BOLD**; metric measurements in *ITALICS* (mm and grams).

| #            | Hose Size |  | After Crimp Max. A          | Cut Factor B                | Min. Ball C                | D                           | E                          | CR Nominal                  | D Nominal |
|--------------|-----------|---|-----------------------------|-----------------------------|----------------------------|-----------------------------|----------------------------|-----------------------------|-----------|
| 418608-3-3CR | -3        | .375-24UNJF-3B  | <b>1.25</b><br><i>31.75</i> | <b>.71</b><br><i>18.03</i>  | <b>.068</b><br><i>1.72</i> | <b>.92</b><br><i>23.37</i>  | <b>.50</b><br><i>12.70</i> | <b>.053</b><br><i>24.04</i> | -         |
| 418638-4-4CR | -4        | .4375-20UNJF-3B   | <b>1.30</b><br><i>33.02</i> | <b>.76</b><br><i>19.30</i>  | <b>.112</b><br><i>2.84</i> | <b>.93</b><br><i>23.62</i>  | <b>.56</b><br><i>14.22</i> | <b>.071</b><br><i>32.20</i> | -         |
| 418638-5-5CR | -5        | .500-20UNJF-3B  | <b>1.46</b><br><i>37.08</i> | <b>.82</b><br><i>20.83</i>  | <b>.164</b><br><i>4.16</i> | <b>1.03</b><br><i>26.16</i> | <b>.62</b><br><i>15.75</i> | <b>.086</b><br><i>39.01</i> | -         |
| 418638-6-6CR | -6        | .5625-18UNJF-3B   | <b>1.58</b><br><i>40.13</i> | <b>.89</b><br><i>22.60</i>  | <b>.218</b><br><i>5.53</i> | <b>1.17</b><br><i>29.72</i> | <b>.69</b><br><i>17.53</i> | <b>.114</b><br><i>51.71</i> | -         |
| 418638-8-8*  | -8        | .750-16UNJF-3B  | <b>1.91</b><br><i>48.51</i> | <b>1.02</b><br><i>25.91</i> | <b>.289</b><br><i>7.34</i> | <b>1.33</b><br><i>33.78</i> | <b>.88</b><br><i>22.35</i> | <b>.197</b><br><i>89.36</i> | -         |

\*Add material designation CR for corrosion resistant steel or D for aluminum nipple and nut with a stainless steel socket.

# 3175 PTFE Flare Hose Assemblies

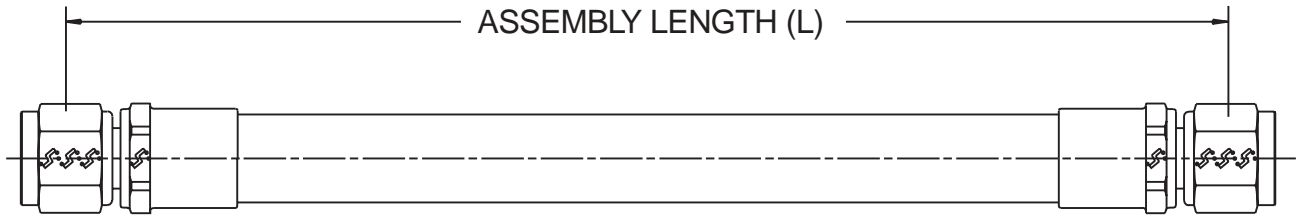

## EXAMPLE OF PART NUMBER

**3175001-8CR-0185**

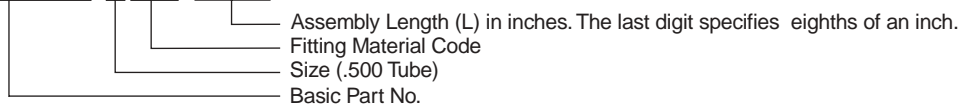

Fittings mate with AS4395/MS33656 connection ends. Assembly length measured from END of nipple to END of nipple.

## Assemblies with Flare Fittings

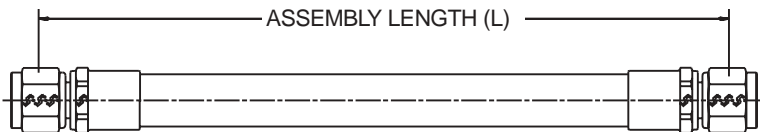

Straight-To-Straight

**NOTE:** English measurements in **BOLD**; metric measurements in *ITALICS* (mm and grams).

| #             | Hose   | Left Hand<br>Hose Fitting | Right Hand<br>Hose Fitting |  | 12 in. (304.8 mm)<br>Ass'y Weight<br>lb. (g) |
|---------------|--------|---------------------------|----------------------------|---|--|
| 3175001-3CR-L | 3175-3 | 418624-3-3CR              | 418624-3-3CR               | <b>0.75</b><br><i>19.05</i>   | <b>.11</b><br><i>49.90</i>                   |
| 3175001-4CR-L | 3175-4 | 418624-4-4CR              | 418624-4-4CR               | <b>1.00</b><br><i>25.40</i>   | <b>.18</b><br><i>81.65</i>                   |
| 3175001-5CR-L | 3175-5 | 418624-5-5CR              | 418624-5-5CR               | <b>1.25</b><br><i>31.75</i>   | <b>.20</b><br><i>90.72</i>                   |
| 3175001-6CR-L | 3175-6 | 418624-6-6CR              | 418624-6-6CR               | <b>2.00</b><br><i>50.80</i>   | <b>.27</b><br><i>122.47</i>                  |
| 3175001-8CR-L | 3175-8 | 418624-8-8CR              | 418624-8-8CR               | <b>2.00</b><br><i>50.80</i>   | <b>.41</b><br><i>185.97</i>                  |

Weights shown are nominal for basic hose with CRES fittings; guaranteed maximum is normally 110% of value shown.

# 3175 PTFE Flare Hose Assemblies

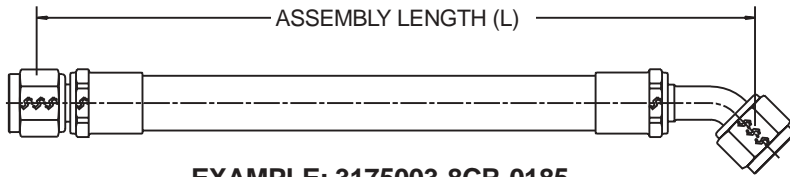

Straight-To-45° Elbow

**NOTE:** English measurements in **BOLD**; metric measurements in *ITALICS* (mm and grams).

| #             | Hose   | Left Hand Hose Fitting | Right Hand Hose Fitting |  | 12 in. (304.8 mm)<br>Ass'y Weight<br>lb. (g) |
|---------------|--------|------------------------|-------------------------|---|--|
| 3175003-3CR-L | 3175-3 | 418624-3-3CR           | 418626-3-3CR            | <b>0.75</b><br><i>19.05</i>   | <b>.12</b><br><i>54.43</i>                   |
| 3175003-4CR-L | 3175-4 | 418624-4-4CR           | 418626-4-4CR            | <b>1.00</b><br><i>25.40</i>   | <b>.19</b><br><i>86.18</i>                   |
| 3175003-5CR-L | 3175-5 | 418624-5-5CR           | 418626-5-5CR            | <b>1.25</b><br><i>31.75</i>   | <b>.21</b><br><i>95.25</i>                   |
| 3175003-6CR-L | 3175-6 | 418624-6-6CR           | 418626-6-6CR            | <b>2.00</b><br><i>50.80</i>   | <b>.29</b><br><i>131.54</i>                  |
| 3175003-8CR-L | 3175-8 | 418624-8-8CR           | 418626-8-8CR            | <b>2.00</b><br><i>50.80</i>   | <b>.44</b><br><i>199.58</i>                  |

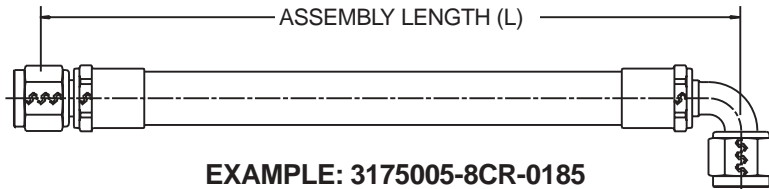

Straight-To-90° Elbow

**NOTE:** English measurements in **BOLD**; metric measurements in *ITALICS* (mm and grams).

| #             | Hose   | Left Hand Hose Fitting | Right Hand Hose Fitting |  | 12 in. (304.8 mm)<br>Ass'y Weight<br>lb. (g) |
|---------------|--------|------------------------|-------------------------|---|--|
| 3175005-3CR-L | 3175-3 | 418624-3-3CR           | 418628-3-3CR            | <b>0.75</b><br><i>19.05</i>   | <b>.12</b><br><i>54.43</i>                   |
| 3175005-4CR-L | 3175-4 | 418624-4-4CR           | 418628-4-4CR            | <b>1.00</b><br><i>25.40</i>   | <b>.19</b><br><i>86.18</i>                   |
| 3175005-5CR-L | 3175-5 | 418624-5-5CR           | 418628-5-5CR            | <b>1.25</b><br><i>31.75</i>   | <b>.21</b><br><i>95.25</i>                   |
| 3175005-6CR-L | 3175-6 | 418624-6-6CR           | 418628-6-6CR            | <b>2.00</b><br><i>50.80</i>   | <b>.30</b><br><i>136.08</i>                  |
| 3175005-8CR-L | 3175-8 | 418624-8-8CR           | 418628-8-8CR            | <b>2.00</b><br><i>50.80</i>   | <b>.44</b><br><i>199.58</i>                  |

Weights shown are nominal for basic hose with CRES fittings; guaranteed maximum is normally 110% of value shown.

# 3175 PTFE Flare Hose Assemblies

## Assemblies with Double Elbow Flare Fittings

### EXAMPLE OF PART NUMBER

**3175060E0185C180**

Basic Part No. \_\_\_\_\_

Twist Angle (\*) In Degrees \_\_\_\_\_

Fitting Material Code \_\_\_\_\_

Assembly Length (L) in inches. The last digit specifies eighths of an inch. \_\_\_\_\_

SIZE CODE FOR DOUBLE ELBOW HOSE ASSEMBLIES \_\_\_\_\_

|                |    |    |    |    |    |
|----------------|----|----|----|----|----|
| Hose Dash Size | -3 | -4 | -5 | -6 | -8 |
| Letter Code    | A  | B  | C  | D  | E  |

Assembly length measured from END of nipple to END of nipple.

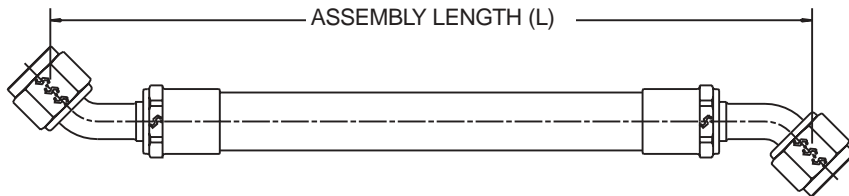

45° Elbow-to-45°-Elbow

**NOTE:** English measurements in **BOLD**; metric measurements in *ITALICS* (mm and grams).

| #             | Hose   | Left Hand<br>Hose Fitting | Right Hand<br>Hose Fitting |  | 12 in. (304.8 mm)<br>Ass'y Weight<br>lb. (g) |
|---------------|--------|---------------------------|----------------------------|---|--|
| 3175060A(L)C* | 3175-3 | 418626-3-3CR              | 418626-3-3CR               | <b>0.75</b><br><i>19.05</i>   | <b>.12</b><br><i>54.43</i>                   |
| 3175060B(L)C* | 3175-4 | 418626-4-4CR              | 418626-4-4CR               | <b>1.00</b><br><i>25.40</i>   | <b>.19</b><br><i>86.18</i>                   |
| 3175060C(L)C* | 3175-5 | 418626-5-5CR              | 418626-5-5CR               | <b>1.25</b><br><i>31.75</i>   | <b>.22</b><br><i>99.79</i>                   |
| 3175060D(L)C* | 3175-6 | 418626-6-6CR              | 418626-6-6CR               | <b>2.00</b><br><i>50.80</i>   | <b>.31</b><br><i>140.61</i>                  |
| 3175060E(L)C* | 3175-8 | 418626-8-8CR              | 418626-8-8CR               | <b>2.00</b><br><i>50.80</i>   | <b>.47</b><br><i>213.19</i>                  |

\*Twist Angle

Weights shown are nominal for basic hose with CRES fittings; guaranteed maximum is normally 110% of value shown.

# 3175 PTFE Flare Hose Assemblies

## Assemblies with Double Elbow Flare Fittings

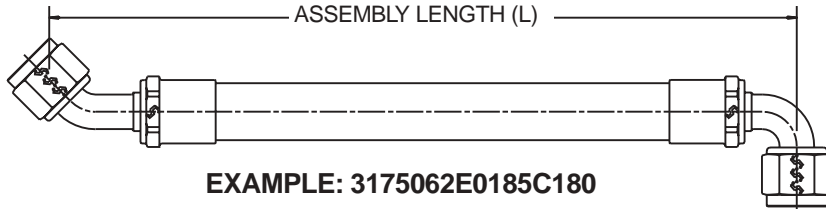

45° Elbow-To-90° Elbow

**NOTE:** English measurements in **BOLD**; metric measurements in *ITALICS* (mm and grams).

| #             | Hose   | Left Hand Hose Fitting | Right Hand Hose Fitting |  | 12 in. (304.8 mm)<br>Ass'y Weight<br>lb. (g) |
|---------------|--------|------------------------|-------------------------|---|--|
| 3175062A(L)C* | 3175-3 | 418626-3-3CR           | 418628-3-3CR            | <b>0.75</b><br><i>19.05</i>   | <b>.12</b><br><i>54.43</i>                   |
| 3175062B(L)C* | 3175-4 | 418626-4-4CR           | 418628-4-4CR            | <b>1.00</b><br><i>25.40</i>   | <b>.19</b><br><i>86.18</i>                   |
| 3175062C(L)C* | 3175-5 | 418626-5-5CR           | 418628-5-5CR            | <b>1.25</b><br><i>31.75</i>   | <b>.22</b><br><i>99.79</i>                   |
| 3175062D(L)C* | 3175-6 | 418626-6-6CR           | 418628-6-6CR            | <b>2.00</b><br><i>50.80</i>   | <b>.32</b><br><i>145.15</i>                  |
| 3175062E(L)C* | 3175-8 | 418626-8-8CR           | 418628-8-8CR            | <b>2.00</b><br><i>50.80</i>   | <b>.47</b><br><i>213.19</i>                  |

\*Twist Angle

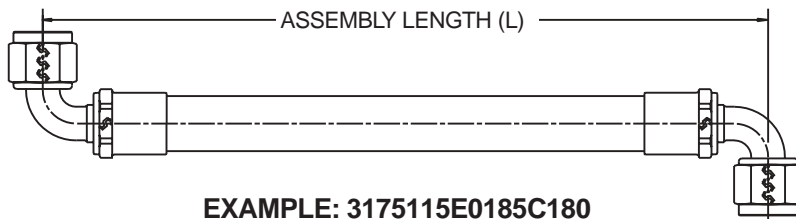

90° Elbow-To-90° Elbow

**NOTE:** English measurements in **BOLD**; metric measurements in *ITALICS* (mm and grams).

| #             | Hose   | Left Hand Hose Fitting | Right Hand Hose Fitting |  | 12 in. (304.8 mm)<br>Ass'y Weight<br>lb. (g) |
|---------------|--------|------------------------|-------------------------|---|--|
| 3175115A(L)C* | 3175-3 | 418628-3-3CR           | 418628-3-3CR            | <b>0.75</b><br><i>19.05</i>   | <b>.12</b><br><i>54.43</i>                   |
| 3175115B(L)C* | 3175-4 | 418628-4-4CR           | 418628-4-4CR            | <b>1.00</b><br><i>25.40</i>   | <b>.20</b><br><i>90.72</i>                   |
| 3175115C(L)C* | 3175-5 | 418628-5-5CR           | 418628-5-5CR            | <b>1.25</b><br><i>31.75</i>   | <b>.23</b><br><i>104.33</i>                  |
| 3175115D(L)C* | 3175-6 | 418628-6-6CR           | 418628-6-6CR            | <b>2.00</b><br><i>50.80</i>   | <b>.32</b><br><i>145.15</i>                  |
| 3175115E(L)C* | 3175-8 | 418628-8-8CR           | 418628-8-8CR            | <b>2.00</b><br><i>50.80</i>   | <b>.47</b><br><i>213.19</i>                  |

\*Twist Angle

Weights shown are nominal for basic hose with CRES fittings; guaranteed maximum is normally 110% of value shown.

# 3175 PTFE Flareless Hose Assemblies

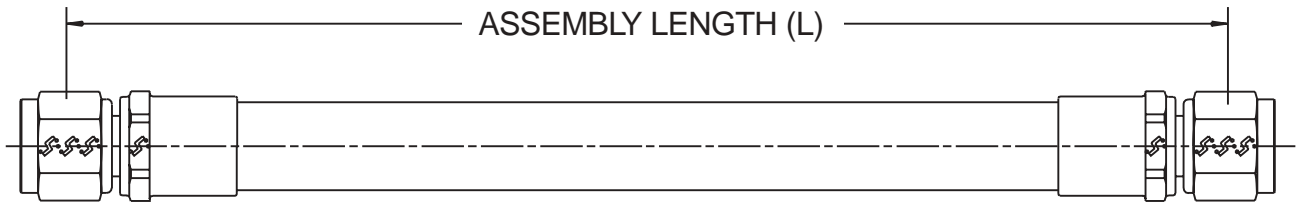

## EXAMPLE OF PART NUMBER

**3175141-8CR-0185**

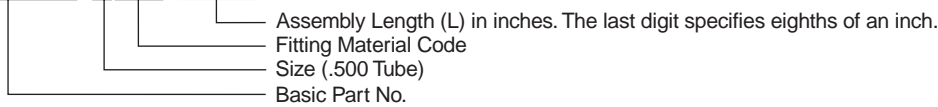

Assembly length measured from END of nipple to END of nipple. See "MEASUREMENT OF FLARELESS HOSE ASSEMBLIES" (page 4) to convert to GAGE POINT to GAGE POINT assembly length.

Fittings mate with AS4375/M33514 type connectors.

## Assemblies with Flareless Fittings

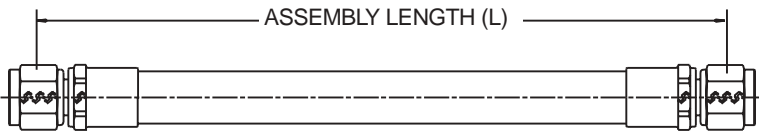

Straight-To-Straight

**NOTE:** English measurements in **BOLD**; metric measurements in *ITALICS* (mm and grams).

| #             | Hose   | Left Hand<br>Hose Fitting | Right Hand<br>Hose Fitting |  | 12 in. (304.8 mm)<br>Ass'y Weight<br>lb. (g) |
|---------------|--------|---------------------------|----------------------------|---|--|
| 3175141-3CR-L | 3175-3 | 418634-3-3CR              | 418634-3-3CR               | <b>0.75</b><br><i>19.05</i>   | <b>.12</b><br><i>54.43</i>                   |
| 3175141-4CR-L | 3175-4 | 418634-4-4CR              | 418634-4-4CR               | <b>1.00</b><br><i>25.40</i>   | <b>.18</b><br><i>81.65</i>                   |
| 3175141-5CR-L | 3175-5 | 418634-5-5CR              | 418634-5-5CR               | <b>1.25</b><br><i>31.75</i>   | <b>.21</b><br><i>95.25</i>                   |
| 3175141-6CR-L | 3175-6 | 418634-6-6CR              | 418634-6-6CR               | <b>2.00</b><br><i>50.80</i>   | <b>.28</b><br><i>127.01</i>                  |
| 3175141-8CR-L | 3175-8 | 418634-8-8CR              | 418634-8-8CR               | <b>2.00</b><br><i>50.80</i>   | <b>.43</b><br><i>195.04</i>                  |

Weights shown are nominal for basic hose with CRES fittings. The guaranteed maximum weight is normally 110% of value shown.

# 3175 PTFE Flareless Hose Assemblies

## Assemblies with Flareless Fittings

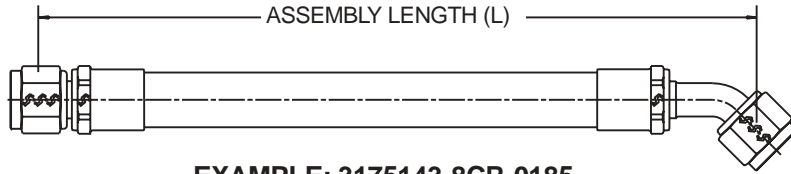

Straight-To-45° Elbow

EXAMPLE: 3175143-8CR-0185

NOTE: English measurements in **BOLD**; metric measurements in *ITALICS* (mm and grams).

| #             | Hose   | Left Hand Hose Fitting | Right Hand Hose Fitting |  | 12 in. (304.8 mm)<br>Ass'y Weight<br>lb. (g) |
|---------------|--------|------------------------|-------------------------|---|--|
| 3175143-3CR-L | 3175-3 | 418634-3-3CR           | 418606-3-3CR            | <b>0.75</b><br><i>19.05</i>   | <b>.13</b><br><i>58.97</i>                   |
| 3175143-4CR-L | 3175-4 | 418634-4-4CR           | 418636-4-4CR            | <b>1.00</b><br><i>25.40</i>   | <b>.18</b><br><i>81.65</i>                   |
| 3175143-5CR-L | 3175-5 | 418634-5-5CR           | 418636-5-5CR            | <b>1.25</b><br><i>31.75</i>   | <b>.22</b><br><i>99.79</i>                   |
| 3175143-6CR-L | 3175-6 | 418634-6-6CR           | 418636-6-6CR            | <b>2.00</b><br><i>50.80</i>   | <b>.29</b><br><i>131.54</i>                  |
| 3175143-8CR-L | 3175-8 | 418634-8-8CR           | 418636-8-8CR            | <b>2.00</b><br><i>50.80</i>   | <b>.45</b><br><i>204.12</i>                  |

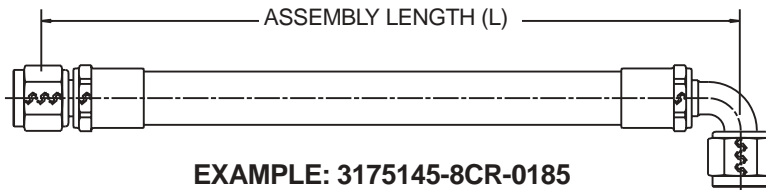

Straight-To-90° Elbow

EXAMPLE: 3175145-8CR-0185

NOTE: English measurements in **BOLD**; metric measurements in *ITALICS* (mm and grams).

| #             | Hose   | Left Hand Hose Fitting | Right Hand Hose Fitting |  | 12 in. (304.8 mm)<br>Ass'y Weight<br>lb. (g) |
|---------------|--------|------------------------|-------------------------|---|--|
| 3175145-3CR-L | 3175-3 | 418634-3-3CR           | 418608-3-3CR            | <b>0.75</b><br><i>19.05</i>   | <b>.13</b><br><i>58.97</i>                   |
| 3175145-4CR-L | 3175-4 | 418634-4-4CR           | 418638-4-4CR            | <b>1.00</b><br><i>25.40</i>   | <b>.19</b><br><i>86.18</i>                   |
| 3175145-5CR-L | 3175-5 | 418634-5-5CR           | 418638-5-5CR            | <b>1.25</b><br><i>31.75</i>   | <b>.22</b><br><i>99.79</i>                   |
| 3175145-6CR-L | 3175-6 | 418634-6-6CR           | 418638-6-6CR            | <b>2.00</b><br><i>50.80</i>   | <b>.30</b><br><i>136.08</i>                  |
| 3175145-8CR-L | 3175-8 | 418634-8-8CR           | 418638-8-8CR            | <b>2.00</b><br><i>50.80</i>   | <b>.46</b><br><i>208.65</i>                  |

Weights shown are nominal for basic hose with CRES fittings; guaranteed maximum is normally 110% of value shown.



# 3175 PTFE Flareless Hose Assemblies

## EXAMPLE OF PART NUMBER

**3175190E0185C180**

Basic Part No. \_\_\_\_\_

Twist Angle (\*) In Degrees  
 Fitting Material Code  
 Assembly Length (L) in inches. The last digit specifies eighths of an Inch.  
 SIZE CODE FOR DOUBLE ELBOW HOSE ASSEMBLIES

|                |    |    |    |    |    |
|----------------|----|----|----|----|----|
| Hose Dash Size | -3 | -4 | -5 | -6 | -8 |
| Letter Code    | A  | B  | C  | D  | E  |

Assembly length measured from END of nipple to END of nipple. See "MEASUREMENT OF FLARELESS ASSEMBLIES" to convert to GAGE POINT to GAGE POINT assembly length.

## Assemblies with Double Elbow Flareless Fittings

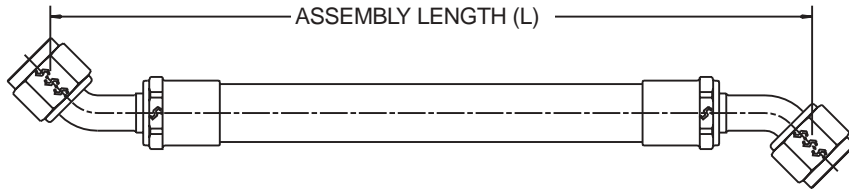

45° Elbow-to-45°-Elbow

**NOTE:** English measurements in **BOLD**; metric measurements in *ITALICS* (mm and grams).

| #             | Hose   | Left Hand<br>Hose Fitting | Right Hand<br>Hose Fitting |  | 12 in. (304.8 mm)<br>Ass'y Weight<br>lb. (g) |
|---------------|--------|---------------------------|----------------------------|---|--|
| 3175190A(L)C* | 3175-3 | 418606-3-3CR              | 418606-3-3CR               | <b>0.75</b><br><i>19.05</i>   | <b>.15</b><br><i>68.04</i>                   |
| 3175190B(L)C* | 3175-4 | 418636-4-4CR              | 418636-4-4CR               | <b>1.00</b><br><i>25.40</i>   | <b>.19</b><br><i>86.18</i>                   |
| 3175190C(L)C* | 3175-5 | 418636-5-5CR              | 418636-5-5CR               | <b>1.25</b><br><i>31.75</i>   | <b>.23</b><br><i>104.33</i>                  |
| 3175190D(L)C* | 3175-6 | 418636-6-6CR              | 418636-6-6CR               | <b>2.00</b><br><i>50.80</i>   | <b>.30</b><br><i>136.08</i>                  |
| 3175190E(L)C* | 3175-8 | 418636-8-8CR              | 418636-8-8CR               | <b>2.00</b><br><i>50.80</i>   | <b>.48</b><br><i>217.72</i>                  |

\*Twist Angle

Weights shown are nominal for basic hose with CRES fittings. The guaranteed maximum weight is normally 110% of value shown.

# 3175 PTFE Flareless Hose Assemblies

## Assemblies with Double Elbow Flareless Fittings

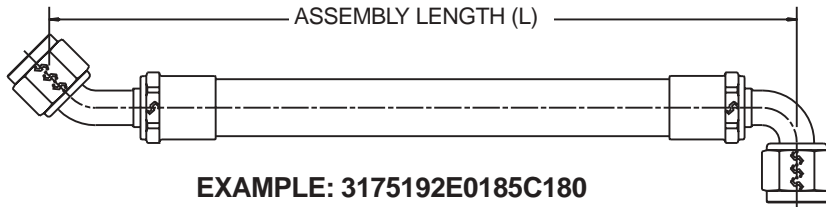

45° Elbow-To-90° Elbow

**NOTE:** English measurements in **BOLD**; metric measurements in *ITALICS* (mm and grams).

| #             | Hose   | Left Hand Hose Fitting | Right Hand Hose Fitting |  | 12 in. (304.8 mm)<br>Ass'y Weight<br>lb. (g) |
|---------------|--------|------------------------|-------------------------|---|--|
| 3175192A(L)C* | 3175-3 | 418606-3-3CR           | 418608-3-3CR            | <b>0.75</b><br><i>19.05</i>   | <b>.15</b><br><i>68.04</i>                   |
| 3175192B(L)C* | 3175-4 | 418636-4-4CR           | 418638-4-4CR            | <b>1.00</b><br><i>25.40</i>   | <b>.19</b><br><i>86.18</i>                   |
| 317519C(L)C*  | 3175-5 | 418636-5-5CR           | 418638-5-5CR            | <b>1.25</b><br><i>31.75</i>   | <b>.23</b><br><i>104.33</i>                  |
| 3175192D(L)C* | 3175-6 | 418636-6-6CR           | 418638-6-6CR            | <b>2.00</b><br><i>50.80</i>   | <b>.30</b><br><i>136.08</i>                  |
| 3175192E(L)C* | 3175-8 | 418636-8-8CR           | 418638-8-8CR            | <b>2.00</b><br><i>50.80</i>   | <b>.49</b><br><i>222.26</i>                  |

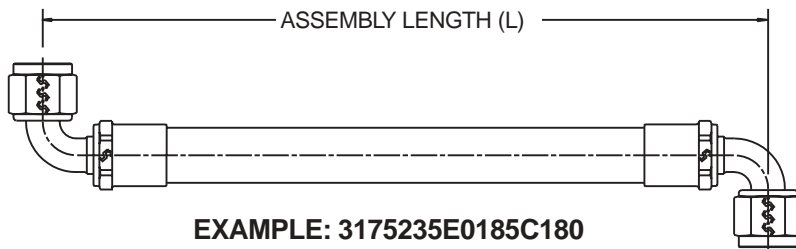

90° Elbow-To-90° Elbow

**NOTE:** English measurements in **BOLD**; metric measurements in *ITALICS* (mm and grams).

| #             | Hose   | Left Hand Hose Fitting | Right Hand Hose Fitting |  | 12 in. (304.8 mm)<br>Ass'y Weight<br>lb. (g) |
|---------------|--------|------------------------|-------------------------|---|--|
| 3175235A(L)C* | 3175-3 | 418608-3-3CR           | 418608-3-3CR            | <b>0.75</b><br><i>19.05</i>   | <b>.15</b><br><i>68.04</i>                   |
| 3175235B(L)C* | 3175-4 | 418638-4-4CR           | 418638-4-4CR            | <b>1.00</b><br><i>25.40</i>   | <b>.19</b><br><i>86.18</i>                   |
| 3175235C(L)C* | 3175-5 | 418638-5-5CR           | 418638-5-5CR            | <b>1.25</b><br><i>31.75</i>   | <b>.23</b><br><i>104.33</i>                  |
| 3175235D(L)C* | 3175-6 | 418638-6-6CR           | 418638-6-6CR            | <b>2.00</b><br><i>50.80</i>   | <b>.31</b><br><i>140.61</i>                  |
| 3175235E(L)C* | 3175-8 | 418638-8-8CR           | 418638-8-8CR            | <b>2.00</b><br><i>50.80</i>   | <b>.49</b><br><i>222.26</i>                  |

Weights shown are nominal for basic hose with CRES fittings. The guaranteed maximum weight is normally 110% of value shown.



## Parker Safety Guide for Selecting and Using Hose, Tubing, Fittings and Related Accessories

Parker Publication No. 4400-B.1 Revised: May, 2002.

**WARNING: Failure or improper selection or improper use of hose, tubing, fittings, assemblies or related accessories ("Products") can cause death, personal injury and property damage. Possible consequences of failure or improper selection or improper use of these Products include but are not limited to:**

- Fittings thrown off at high speed.
- High velocity fluid discharge.
- Electrocution from high voltage electric powerlines.
- Contact with suddenly moving or falling objects that are controlled by the conveyed fluid.
- Injections by high-pressure fluid discharge..
- Dangerous whipping Hose.
- Contact with conveyed fluids that may be hot, cold, toxic or otherwise injurious.
- Sparking or explosion caused by static electricity buildup or other sources of electricity.
- Sparking or explosion while spraying paint or flammable liquids.
- Injury resulting from inhalation, injection or explosion of fluids.

Before selecting or using any of these Products, it is important that you read and follow the instructions below. Only hose from Parker's Stratoflex Products Division is approved for in flight aerospace applications, and no other Hose can be used for such in flight applications.

### 1.0 GENERAL INSTRUCTIONS

- 1.1 Scope:** This safety guide provides instructions for selecting and using (including assembling, installing, and maintaining) these Products. For convenience, all rubber and/or thermoplastic products commonly called "Hose" or "tubing" are called "Hose" in this safety guide. All Assemblies made with Hose are called "Hose Assemblies". All products commonly called "Fittings" or "couplings" are called "Fittings". All related accessories (including crimping and swaging machines and tooling) are called "Related Accessories". This safety guide is a supplement to and is to be used with the specific Parker publications for the specific Hose, Fittings and Related Accessories that are being considered for use.
- 1.2 Fail-Safe:** Hose and Hose Assemblies can and do fail without warning for many reasons. Design all systems and equipment in a fail-safe mode, so that failure of the Hose or Hose Assembly or Fitting will not endanger persons or property.
- 1.3 Distribution:** Provide a copy of this safety guide to each person that is responsible for selecting or using Hose and Fitting products. Do not select or use Parker Hose or Fittings without thoroughly reading and understanding this safety guide as well as the specific Parker publications for the products considered or selected.
- 1.4 User Responsibility:** Due to the wide variety of operating conditions and applications for Hose and Fittings, Parker and its distributors do not represent or warrant that any particular Hose or Fitting is suitable for any specific end use system. This safety guide does not analyze all technical parameters that must be considered in selecting a product. The user, through its own analysis and testing, is solely responsible for:
- Making the final selection of the Hose and Fitting.
  - Assuring that the user's requirements are met and that the application presents no health or safety hazards.
  - Providing all appropriate health and safety warnings on the equipment on which the Hose and Fittings are used.
  - Assuring compliance with all applicable government and industry standards.
- 1.5 Additional Questions:** Call the appropriate Parker technical service department if you have any questions or require any additional information. See the Parker publication for the product being considered or used, or call 1-800-CPARKER, or go to [www.parker.com](http://www.parker.com) for telephone numbers of the appropriate technical service department.

### 2.0 HOSE AND FITTING SELECTION INSTRUCTIONS

- 2.1 Electrical Conductivity:** Certain applications require that the Hose be nonconductive to prevent electrical current flow. Other applications require the Hose and the Fitting and the Hose/Fitting interface to be sufficiently conductive to drain off static electricity. Extreme care must be exercised when selecting Hose and Fittings for these or any other applications in which electrical conductivity or nonconductivity is a factor.
- The electrical conductivity or nonconductivity of Hose and Fittings is dependent upon many factors and may be susceptible to change. These factors include but are not limited to the various materials used to make the Hose and the Fittings. Fitting finish (some Fitting finishes are electrically conductive while others are nonconductive), manufacturing methods (including moisture control), how the Fittings contact the Hose, age and amount of deterioration or damage or other changes, moisture content of the Hose at any particular time and other factors.
- The following are considerations for electrically nonconductive and conductive Hose. For other applications consult the individual catalog pages and the appropriate industry or regulatory standards for proper selection.
- 2.1.1 Electrically Nonconductive Hose:** Certain applications require that the Hose be nonconductive to prevent electrical current flow or to maintain electrical isolation. For these applications that require Hose to be electrically nonconductive, including but not limited to applications near high voltage electric lines, only special nonconductive Hose can be used. The manufacturer of the equipment in which the nonconductive Hose is to be used must be consulted to be certain that the Hose and Fittings that are selected are proper for the application. Do not use any Parker Hose or Fitting for any such application requiring nonconductive Hose, including but not limited to applications near high voltage electric lines, unless (i) the application is expressly approved in the Parker technical publication for the product, (ii) the Hose is marked "nonconductive", and (iii) the manufacturer of the equipment on which the Hose is to be used specifically approves the particular Parker Hose and Fitting for such use.
- 2.1.2 Electrically Conductive Hose:** Parker manufactures special Hose for certain applications that require electrically conductive Hose.
- Parker manufactures special Hose for conveying paint in airless paint spraying applications. This Hose is labeled "Electrically Conductive Airless Paint Spray Hose" on its layline and packaging. This Hose must be properly connected to the appropriate Parker Fittings and properly grounded in order to dissipate dangerous static charge buildup, which occurs in all airless paint spraying applications. Do not use any other Hose for airless paint spraying, even if electrically conductive. Use of any other Hose or failure to properly connect the Hose can cause a fire or an explosion resulting in death, personal injury, and property damage.
- Parker manufactures a special Hose for certain compressed natural gas ("CNG") applications where static electricity buildup may occur. Parker CNG Hose Assemblies comply with AGA Requirements 1-93, "Hoses for Natural Gas Vehicles and Fuel Dispensers". This Hose is labeled "Electrically Conductive for CNG Use" on its layline and packaging. This Hose must be properly connected to the appropriate Parker Fittings and properly grounded in order to dissipate dangerous static charge buildup, which occurs in, for example, high velocity CNG dispensing or transfer. Do not use any other Hose for CNG applications where static charge buildup may occur, even if electrically conductive. Use of other Hoses in CNG applications or failure to properly connect or ground this Hose may cause a fire or an explosion resulting in death, personal injury, and property damage. Care must also be taken to protect against CNG permeation through the Hose wall. See section 2.6, Permeation, for more information. Parker CNG Hose is intended for dispenser and vehicle use at a maximum temperature of 180°F. Parker CNG Hose should not be used in confined spaces or unventilated areas or areas exceeding 180° F. Final Assemblies must be tested for leaks. CNG Hose Assemblies should be tested on a monthly basis for conductivity per AGA 1-93.
- Parker manufactures special Hose for aerospace in flight applications. Aerospace in flight application employing Hose to transmit fuel, lubricating fluids and hydraulic fluids require a special Hose with a conductive inner tube. This Hose for in flight applications is available only from Parker's Stratoflex Products Division. Do not use any other Parker Hose for in flight applications, even if electrically conductive. Use of other Hoses for in flight applications or failure to properly connect or ground this Hose can cause a fire or an explosion resulting in death, personal injury, and property damage. These Hose Assemblies for in flight applications must meet all applicable aerospace industry, aircraft engine, and aircraft requirements.
- 2.2 Pressure:** Hose selection must be made so that the published maximum recommended working pressure of the Hose is equal to or greater than the maximum system pressure. Surge pressures or peak transient pressures in the system must be below the published maximum working pressure for the Hose. Surge pressures and peak pressures can usually only be determined by sensitive electrical instrumentation that measures and indicates pressures at millisecond intervals. Mechanical pressure gauges indicate only average pressures and cannot be used to determine surge pressures or peak transient pressures. Published burst pressure ratings for Hose is for manufacturing test purposes only and is no indication that the Product can be used in applications at the burst pressure or otherwise above the published maximum recommended working pressure.
- 2.3 Suction:** Hoses used for suction applications must be selected to insure that the Hose will withstand the vacuum and pressure of the system. Improperly selected Hose may collapse in suction application.
- 2.4 Temperature:** Be certain that fluid and ambient temperatures, both steady and transient, do not exceed the limitations of the Hose. Temperatures below and above the recommended limit can degrade Hose to a point where a failure may occur and release fluid. Properly insulate and protect the Hose Assembly when routing near hot objects (e.g. manifolds). Do not use any Hose in any application where failure of the Hose could result in the conveyed fluids (or vapors or mist from the conveyed fluids) contacting any open flame, molten metal, or other potential fire ignition source that could cause burning or explosion of the conveyed fluids or vapors.
- 2.5 Fluid Compatibility:** Hose Assembly selection must assure compatibility of the Hose tube, cover, reinforcement, and Fittings with the fluid media used. See the fluid compatibility chart in the Parker publication for the product being considered or used. This information is offered only as a guide. Actual service life can only be determined by the end user by testing under all extreme conditions and other analysis.
- Hose that is chemically compatible with a particular fluid must be assembled using Fittings and adapters containing likewise compatible seals.
- 2.6 Permeation:** Permeation (that is, seepage through the Hose) will occur from inside the Hose to outside when Hose is used with gases, liquid and gas fuels, and refrigerants (including but not limited to such materials as helium, diesel fuel, gasoline, natural gas, or LPG). This permeation may result in high concentrations of vapors, which are potentially flammable, explosive, or toxic, and in loss of fluid. Dangerous explosions, fires, and other hazards can result when using the wrong Hose for such applications. The system designer must take into account the fact that this permeation will take place and must not use Hose if this permeation could be hazardous. The system designer must take into account all legal, government, insurance, or any other special regulations, which govern the use of fuels and refrigerants. Never use a Hose even though the fluid compatibility is acceptable without considering the potential hazardous effects that can result from permeation through the Hose Assembly.
- Permeation of moisture from outside the Hose to inside the Hose will occur in Hose Assemblies, regardless of internal pressure. If this moisture permeation would have detrimental effects (particularly, but not limited to refrigeration and air conditioning systems), incorporation of sufficient drying capacity in the system or other appropriate system safeguards should be selected and used.
- 2.7 Size:** Transmission of power by means of pressurized fluid varies with pressure and rate of flow. The size of the components must be adequate to keep pressure losses to a minimum, and avoid damage due to heat generation or excessive fluid velocity.

- 2.8 Routing:** Attention must be given to optimum routing to minimize inherent problems (kinking or flow restriction due to Hose collapse, twisting of the Hose, proximity to hot objects or heat sources).
- 2.9 Environment:** Care must be taken to insure that the Hose and Fittings are either compatible with or protected from the environment (that is, surrounding conditions) to which they are exposed. Environmental conditions including but not limited to ultraviolet radiation, sunlight, heat, ozone, moisture, water, salt water, chemicals and air pollutants can cause degradation and premature failure.
- 2.10 Mechanical Loads:** External forces can significantly reduce Hose life or cause failure. Mechanical loads which must be considered include excessive flexing, twist, kinking, tensile or side loads, bend radius, and vibration. Use of swivel type Fittings or adapters may be required to insure no twist is put into the Hose. Unusual applications may require special testing prior to Hose selection.
- 2.11 Physical Damage:** Care must be taken to protect Hose from wear, snagging, kinking, bending smaller than minimum bend radius, and cutting, any of which can cause premature Hose failure. Any Hose that has been kinked or bent to a radius smaller than the minimum bend radius, and any Hose that has been cut or is cracked or is otherwise damaged, should be removed and discarded.
- 2.12 Proper End Fitting:** See instructions 3.2 through 3.5. These recommendations may be substantiated by testing to industry standards such as SAE J517 for hydraulic applications, or MIL-A-5070, AS1339, or AS3517 for Hoses from Parker's Stratoflex Products Division for aerospace applications.
- 2.13 Length:** When establishing a proper Hose length, motion absorption, Hose length changes due to pressure, and Hose and machine tolerances and movement must be considered.
- 2.14 Specifications and Standards:** When selecting Hose and Fittings, government, industry, and Parker specifications and recommendations must be reviewed and followed as applicable.
- 2.15 Hose Cleanliness:** Hose components may vary in cleanliness levels. Care must be taken to insure that the Hose Assembly selected has an adequate level of cleanliness for the application.
- 2.16 Fire Resistant Fluids:** Some fire resistant fluids that are conveyed by Hose require the use of the same type of Hose as used with petroleum base fluids. Some such fluids require a special Hose, while a few fluids will not work with any Hose at all. See instructions 2.5 and 1.5. The wrong Hose may fail after a very short service. In addition, all liquids but pure water may burn fiercely under certain conditions, and even pure water leakage may be hazardous.
- 2.17 Radiant Heat:** Hose can be heated to destruction without contact by such nearby items as hot manifolds or molten metal. The same heat source may then initiate a fire. This can occur despite the presence of cool air around the Hose.
- 2.18 Welding or Brazing:** When using a torch or arc-welder in close proximity to hydraulic lines, the hydraulic lines should be removed or shielded with appropriate fire resistant materials. Flame or weld spatter could burn through the Hose and possibly ignite escaping fluid resulting in a catastrophic failure. Heating of plated parts, including Hose Fittings and adapters, above 450° F (232° C) such as during welding, brazing, or soldering may emit deadly gases.
- 2.19 Atomic Radiation:** Atomic radiation affects all materials used in Hose Assemblies. Since the long-term effects may be unknown, do not expose Hose Assemblies to atomic radiation.
- 2.20 Aerospace Applications:** The only Hose and Fittings that may be used for in flight aerospace applications are those available from Parker's Stratoflex Products Division. Do not use any other Hose or Fittings for in flight applications. Do not use any Hose or Fittings from Parker's Stratoflex Products Division with any other Hose or Fittings, unless expressly approved in writing by the engineering manager or chief engineer of Stratoflex Products Division and verified by the user's own testing and inspection to aerospace industry standards.
- 2.21 Unlocking Couplings:** Ball locking couplings or other couplings with disconnect sleeves can unintentionally disconnect if they are dragged over obstructions or if the sleeve is bumped or moved enough to cause disconnect. Threaded couplings should be considered where there is a potential for accidental uncoupling.
- 3.0 HOSE AND FITTING ASSEMBLY AND INSTALLATION INSTRUCTIONS**
- 3.1 Component Inspection:** Prior to Assembly, a careful examination of the Hose and Fittings must be performed. All components must be checked for correct style, size, catalog number, and length. The Hose must be examined for cleanliness, obstructions, blisters, cover looseness, kinks, cracks, cuts or any other visible defects. Inspect the Fitting and sealing surfaces for burns, nicks, corrosion or other imperfections. Do NOT use any component that displays any signs of nonconformance.
- 3.2 Hose and Fitting Assembly:** Do not assemble a Parker Fitting on a Parker Hose that is not specifically listed by Parker for that Fitting, unless authorized in writing by the engineering manager or chief engineer of the appropriate Parker division. Do not assemble a Parker Fitting on another manufacturer's Hose or a Parker Hose to another manufacturer's Fitting unless: (i) the engineering manager or chief engineer of the appropriate Parker division approves the Assembly in writing or that combination is expressly approved in the appropriate Parker literature for the specific Parker product, and (ii) the user verifies the Assembly and the application through analysis and testing. For Parker Hose that does not specify a Parker Fitting, the user is solely responsible for the selection of the proper Fitting and Hose Assembly procedures. See instruction 1.4.
- 3.3 Related Accessories:** Do not crimp or swage any Parker Hose or Fittings with anything but the listed swage or crimp machine and dies in accordance with Parker published instructions. Do not crimp or swage another manufacturer's Fitting with a Parker crimp or swage die unless authorized in writing by the engineering manager or chief engineer of the appropriate Parker division.
- 3.4 Parts:** Do not use any Parker Fitting part (including but not limited to socket, shell, nipple, or insert) except with the correct Parker mating parts, in accordance with Parker published instructions, unless authorized in writing by the engineering manager or chief engineer of the appropriate Parker division.
- 3.5 Reusable/Permanent:** Do not reuse any field attachable (reusable) Hose Fitting that has blown off or pulled off a Hose. Do not assemble Fittings to any previously used hydraulic Hose that was in service, for use in a fluid power application.
- 3.6 Pre-Installation Inspection:** Prior to installation, a careful examination of the Hose Assembly must be performed. Inspect the Hose Assembly for any damage or defects. Do NOT use any Hose Assembly that displays any signs of nonconformance.
- 3.7 Minimum Bend Radius:** Installation of a Hose at less than the minimum listed bend radius may significantly reduce the Hose life. Particular attention must be given to preclude sharp bending at the Hose to Fitting juncture. Any bending during installation at less than the minimum bend radius must be avoided. If any Hose is kinked during installation, the Hose must be discarded.
- 3.8 Twist Angle and Orientation:** Hose Assembly installation must be such that relative motion of machine components does not produce twisting.
- 3.9 Securement:** In many applications, it may be necessary to restrain, protect, or guide the Hose to protect it from damage by unnecessary flexing, pressure surges, and contact with other mechanical components. Care must be taken to insure such restraints do not introduce additional stress or wear points.
- 3.10 Proper Connection of Ports:** Proper physical installation of the Hose Assembly requires a correctly installed port connection insuring that no twist or torque is transferred to the Hose when the Fittings are being tightened or otherwise during use.
- 3.11 External Damage:** Proper installation is not complete without insuring that tensile loads, side loads, kinking, flattening, potential abrasion, thread damage, or damage to sealing surfaces are corrected or eliminated. See instruction 2.10.
- 3.12 System Checkout:** All air entrapment must be eliminated and the system pressurized to the maximum system pressure (at or below the Hose maximum working pressure) and checked for proper function and freedom from leaks. Personnel must stay out of potential hazardous areas while testing and using.
- 3.13 Routing:** The Hose Assembly should be routed in such a manner so if a failure does occur, the escaping media will not cause personal injury or property damage. In addition, if fluid media comes in contact with hot surfaces, open flame, or sparks, a fire or explosion may occur. See section 2.4.
- 4.0 HOSE AND FITTING MAINTENANCE AND REPLACEMENT INSTRUCTIONS**
- 4.1** Even with proper selection and installation, Hose life may be significantly reduced without a continuing maintenance program. The severity of the application, risk potential from a possible Hose failure, and experience with any Hose failures in the application or in similar applications should determine the frequency of the inspection and the replacement for the Products so that Products are replaced before any failure occurs. A maintenance program must be established and followed by the user and, at minimum, must include instructions 4.2 through 4.7.
- 4.2 Visual Inspection Hose/Fitting:** Any of the following conditions require immediate shut down and replacement of the Hose Assembly
- Fitting slippage on Hose;
  - Damaged, cracked, cut or abraded cover (any reinforcement exposed);
  - Hard, stiff, heat cracked, or charred Hose;
  - Cracked, damaged, or badly corroded Fittings;
  - Leaks at Fitting or in Hose;
  - Kinked, crushed, flattened or twisted Hose; and
  - Blistered, soft, degraded, or loose cover.
- 4.3 Visual Inspection All Other:** The following items must be tightened, repaired, corrected or replaced as required:
- Leaking port conditions;
  - Excess dirt buildup;
  - Worn clamps, guards or shields; and
  - System fluid level, fluid type and any air entrapment.
- 4.4 Functional Test:** Operate the system at maximum operating pressure and check for possible malfunctions and leaks. Personnel must avoid potential hazardous areas while testing and using the system. See section 2.2
- 4.5 Replacement Intervals:** Hose Assemblies and elastomeric seals used on Hose Fittings and adapters will eventually age, harden, wear and deteriorate under thermal cycling and compression set. Hose Assemblies and elastomeric seals should be inspected and replaced at specific replacement intervals, based on previous service life, government or industry recommendations, or when failures could result in unacceptable downtime, damage, or injury risk. See section 1.2.
- 4.6 Hose Inspection and Failure:** Hydraulic power is accomplished by utilizing high-pressure fluids to transfer energy and do work. Hoses, Fittings, and Hose Assemblies all contribute to this by transmitting fluids at high pressures. Fluids under pressure can be dangerous and potentially lethal and, therefore, extreme caution must be exercised when working with fluids under pressure and handling the Hoses transporting the fluids. From time to time, Hose Assemblies will fail if they are not replaced at proper time intervals. Usually these failures are the result of some form of misapplication, abuse, wear, or failure to perform proper maintenance. When Hoses fail, generally the high-pressure fluids inside escape in a stream which may or may not be visible to the user. Under no circumstances should the user attempt to locate the leak by "feeling" with their hands or any other part of their body. High-pressure fluids can and will penetrate the skin and cause severe tissue damage and possibly loss of limb. Even seemingly minor hydraulic fluid injection injuries must be treated immediately by a physician with knowledge of the tissue damaging properties of hydraulic fluid. If a Hose failure occurs, immediately shut down the equipment and leave the area until pressure has been completely released from the Hose Assembly. Simply shutting down the hydraulic pump may or may not eliminate the pressure in the Hose Assembly. Many times check valves, etc., are employed in a system and can cause pressure to remain in a Hose Assembly even when pumps or equipment are not operating. Tiny holes in the Hose, commonly known as pinholes, can eject small, dangerously powerful but hard to see streams of hydraulic fluid. It may take several minutes or even hours for the pressure to be relieved so that the Hose Assembly may be examined safely. Once the pressure has been reduced to zero, the Hose Assembly may be taken off the equipment and examined. It must always be replaced if a failure has occurred. Never attempt to patch or repair a Hose Assembly that has failed. Consult the nearest Parker distributor or the appropriate Parker division for Hose Assembly replacement information. Never touch or examine a failed Hose Assembly unless it is obvious that the Hose no longer contains fluid under pressure. The high-pressure fluid is extremely dangerous and can cause serious and potentially fatal injury.
- 4.7 Elastomeric seals:** Elastomeric seals will eventually age, harden, wear and deteriorate under thermal cycling and compression set. Elastomeric seals should be inspected and replaced.
- 4.8 Refrigerated Gases:** Special care should be taken when working with refrigeration systems. Sudden escape of refrigerant gases can cause blindness if the escaping gases contact the eye and can cause freezing or other severe injuries if it contacts any other portion of the body.
- 4.9 Compressed natural gas (CNG):** Parker CNG Hose Assemblies should be tested after installation and before use, and at least on a monthly basis per AGA 1-93 Section 4.2 "Visual Inspection Hose/Fitting". The recommended procedure is to pressurize the Hose and check for leaks and to visually inspect the Hose for damage.
- Caution:** Matches, candles, open flame or other sources of ignition shall not be used for Hose inspection. Leak check solutions should be rinsed off after use.



# Offer of Sale

The items described in this document and other documents or descriptions provided by Parker Hannifin Corporation, its subsidiaries and its authorized distributors are hereby offered for sale at prices to be established by Parker Hannifin Corporation, its subsidiaries and its authorized distributors. This offer and its acceptance by any customer ("Buyer") shall be governed by all of the following Terms and Conditions. Buyer's order for any such item, when communicated to Parker Hannifin Corporation, its subsidiary or an authorized distributor ("Seller") verbally or in writing, shall constitute acceptance of this offer.

**1. Terms and Conditions of Sale:** All descriptions, quotations, proposals, offers, acknowledgments, acceptances and sales of Seller's products are subject to and shall be governed exclusively by the terms and conditions stated herein. Buyer's acceptance of any offer to sell is limited to these terms and conditions. Any terms or conditions in addition to, or inconsistent with those stated herein, proposed by Buyer in any acceptance of an offer by Seller, are hereby objected to. No such additional, different or inconsistent terms and conditions shall become part of the contract between Buyer and Seller unless expressly accepted in writing by Seller. Seller's acceptance of any offer to purchase by Buyer is expressly conditional upon Buyer's assent to all the terms and conditions stated herein, including any terms in addition to, or inconsistent with those contained in Buyer's offer. Acceptance of Seller's products shall in all events constitute such assent.

**2. Payment:** Payment shall be made by Buyer net 30 days from the date of delivery of the items purchased hereunder. Any claims by Buyer for omissions or shortages in a shipment shall be waived unless Seller receives notice thereof within 30 days after Buyer's receipt of the shipment.

**3. Delivery:** Unless otherwise provided on the face hereof, delivery shall be made F.O.B. Seller's plant. Regardless of the method of delivery, however, risk of loss shall pass to Buyer upon Seller's delivery to a carrier. Any delivery dates shown are approximate only and Seller shall have no liability for any delays in delivery.

**4. Warranty:** Seller warrants that the items sold thereunder shall be free from defects in material or workmanship for a period of 365 days from the date of shipment to Buyer, or 2,000 hours of use, whichever expires first. **THIS WARRANTY COMPRISES THE SOLE AND ENTIRE WARRANTY PERTAINING TO ITEMS PROVIDED HEREUNDER. SELLER MAKES NO OTHER WARRANTY, GAURANTEE, OR REPRESENTATION OF ANY KIND WHATSOEVER. ALL OTHER WARRANTIES, INCLUDING BUT NOT LIMITED TO, MERCHANTABILITY AND FITNESS FOR PURPOSE, WHETHER EXPRESS, IMPLIED, OR ARISING BY OPERATION OF LAW, TRADE USAGE, OR COURSE OF DEALING ARE HEREBY DISCLAIMED. NOTWITHSTANDING THE FOREGOING, THERE ARE NO WARRANTIES WHATSOEVER ON ITEMS BUILT OR ACQUIRED WHOLELY OR PARTIALLY, TO BUYER'S DESIGNS OR SPECIFICATIONS.**

**5. Limitation Of Remedy: SELLER'S LIABILITY ARISING FROM OR IN ANY WAY CONNECTED WITH THE ITEMS SOLD OR THIS CONTRACT SHALL BE LIMITED EXCLUSIVELY TO REPAIR OR REPLACEMENT OF THE ITEMS SOLD OR REFUND OF THE PURCHASE PRICE PAID BY BUYER, AT SELLER'S SOLE OPTION. IN NO EVENT SHALL SELLER BE LIABLE FOR ANY INCIDENTAL, CONSEQUENTIAL OR SPECIAL DAMAGES OF ANY KIND OR NATURE WHATSOEVER, INCLUDING BUT NOT LIMITED TO LOST PROFITS ARISING FROM OR IN ANY WAY CONNECTED WITH THIS AGREEMENT OR ITEMS SOLD HEREUNDER, WHETHER ALLEGED TO ARISE FROM BREACH OF CONTRACT, EXPRESS OR IMPLIED WARRANTY, OR IN TORT, INCLUDING WITHOUT LIMITATION, NEGLIGENCE, FAILURE TO WARN OR STRICT LIABILITY.**

**6. Changes, Reschedules and Cancellations:** Buyer may request to modify the designs or specifications for the items sold herunder as well as the quantities and delivery dates thereof, or may request to cancel all or part of this order, however, no such requested modification or cancellation shall become part of the contract between Buyer and Seller unless accepted by Seller in a written amendment to this Agreement. Acceptance of any such requested modification or cancellation shall be at Seller's discretion, and shall be upon such terms and conditions as Seller may require.

**7. Special Tooling:** A tooling charge may be imposed for any special tooling, including without limitation, dies, fixtures, molds and patterns, acquired to manufacture items sold pursuant to this contract. Such special tooling shall be and remain Seller's property notwithstanding payment of any charges by Buyer. In no event will Buyer acquire any interest in apparatus belonging to Seller which is utilized in the manufacture of the items sold hereunder, even if such apparatus has been specially converted or adapted for such manufacture and notwithstanding any charges paid by Buyer. Unless otherwise agreed, Seller shall have the right to alter, discard or otherwise dispose of any special tooling or other property in its sole discretion at any time.

**8. Buyer's Property:** Any designs, tools, patterns, materials, drawings, confidential information or equipment furnished by Buyer or any other items which become Buyer's property, may be considered obsolete and may be destroyed by Seller after two (2) consecutive years have elapsed without Buyer placing an order for the items which are manufactured using such property. Seller shall not be responsible for any loss or damage to such property while it is in Seller's possession or control.

**9. Taxes:** Unless otherwise indicated on the face hereof, all prices and charges are exclusive of excise, sales, use, property, occupational or like taxes which may be imposed by any taxing authority upon the manufacture, sale or delivery of the items sold hereunder. If any such taxes must be paid by Seller of if Seller is liable for the collection of such tax, the amount thereof shall be in addition to the amounts for the items sold. Buyer agrees to pay all such taxes or to reimburse Seller therefore upon receipt of its invoice. If Buyer claims exemption from any sales, use or other tax imposed by any taxing authority, Buyer shall save Seller harmless from and against any such tax, together with any interest or penalties thereon which may be assessed if the items are held to be taxable.

**10. Indemnity For Infringement of Intellectual Property Rights:** Seller shall have no liability for infringement of any patents, trademarks, copyrights, trade dress, trade secrets or similar rights except as provided in this Part 10. Seller will defend and indemnify Buyer against allegations of infringement of U.S. patents, U.S. trademarks, copyrights, trade dress and trade secrets (hereinafter "Intellectual Property Rights"). Seller will defend at its expense and will pay the cost of any settlement or damages awarded in an action brought against Buyer based on an allegation that an item sold pursuant to this contract infringes in the Intellectual Property Rights of a third party. Seller's obligation to defend and indemnify Buyer is contingent on Buyer notifying Seller within ten (10) days after Buyer becomes aware of such allegations of infringement, and Seller having sole control over the defense of any allegations or actions including all negotiations for settlement or compromise. If an item sold hereunder is subject to a claim that it infringes the Intellectual Property Rights of a third party, Seller may, at its sole expense and options, procure for Buyer the right to continue using said item, replace or modify said item so as to make it noninfringing, or offer to accept return of said item and return the purchase price less a reasonable allowance for depreciation. Notwithstanding the foregoing, Seller shall have no liability for claims of infringement based on information provided by Buyer, or directed to items delivered hereunder for which the designs are specified in whole or part by Buyer, or infringements resulting from the modification, combination or use in a system of any item sold hereunder. The foregoing provisions of this Part 10 shall constitute Seller's sole and exclusive liability and Buyer's sole and exclusive remedy for infringement of Intellectual Property Rights.

If a claim is based on information provided by Buyer or if the design for an item delivered hereunder is specified in whole or in part by Buyer, Buyer shall defend and indemnify Seller for all costs, expenses or judgments resulting from any claim that such item infringes any patent, trademark, copyright, trade dress, trade secret or any similar right.

**11. Force Majeure:** Seller does not assume the risk of and shall not be liable for delay or failure to perform any of Seller's obligations by reason of circumstances beyond the reasonable control of Seller (hereinafter "Events of Force Majeure"). Events of Force Majeure shall include without limitation, accidents, acts of God, strikes or labor disputes, acts, laws, rules or regulations of any government or government agency, fires, floods, delays or failures in delivery of carriers or suppliers, shortages of materials and any other cause beyond Seller's control.

**12. Entire Agreement/Governing Law:** The terms and conditions set forth herein, together with any amendments, modifications and any different terms or conditions expressly accepted by Seller in writing, shall constitute the entire Agreement concerning the items sold, and there are no oral or other representations or agreements which pertain thereto. This Agreement shall be governed in all respects by the law of the State of Ohio. No actions arising out of the sale of the items sold hereunder or this Agreement may be brought by either party more than two (2) years after the cause of action accrues.



## ***Stratoflex Products Division Sales Offices***

---

**Stratoflex Products Division**  
Parker Hannifin Corporation  
220 Roberts Cut-Off Road  
Fort Worth, Texas 76114 U.S.A.  
Phone: (817) 738-6543  
Fax: (817) 738-9920

**Stratoflex Products Division,**  
Couplings Business Unit  
Parker Hannifin Corporation  
3800 Calle Tecate  
Camarillo, CA 93012 U.S.A.  
Phone: (805) 484-8533  
Fax: (805) 987-8958

**Website:** [www.parker.com/stratoflex](http://www.parker.com/stratoflex)

